

**Data Sheets of AVA technology  
Chip Type White LED**

**Model : T3020**

**AVA technology CO..**

**2640 S. Myrtle Ave. Suite 6**

**Monrovia,CA 91016**

**P: 626-574-7726**

**F: 626-574-7732**

**<http://www.led4light.com>**

### Thin Top View with Reflector

#### 1. FEATURES

- High intensity with small package, ideal for backlighting
- Wide viewing angle ( 120° )
- Suitable for all SMT assembly methods
- Suitable for all soldering methods
- Delivery on 8mm tape reels



#### 2. APPLICATIONS

Automotive: indoor/outdoor lighting.

Signal and symbol lightings

Backlighting (TFT-LCD displays, PDA, Digital Camera, Navigator.....)

All applications in notice high intensities are required

Strobe light

Channel Letter

| Type  | Color of Emission | Color of the Light Emitting Area | Luminous intensity<br>$I_v$ (mcd)<br>$I_F = 20\text{mA}$ |
|-------|-------------------|----------------------------------|--|
| T3020 | White             | Colored                          | 600 ~1650  |

#### Materials Construction

| ITEM                | MATERIALS               |
|---------------------|-------------------------|
| Package             | Heat-Resistant Polymer  |
| Encapsulating Resin | Heat-Resistant Resin    |
| Electrodes          | Ag Plating Copper Alloy |

### 3. OUTLINE DIMENSION:

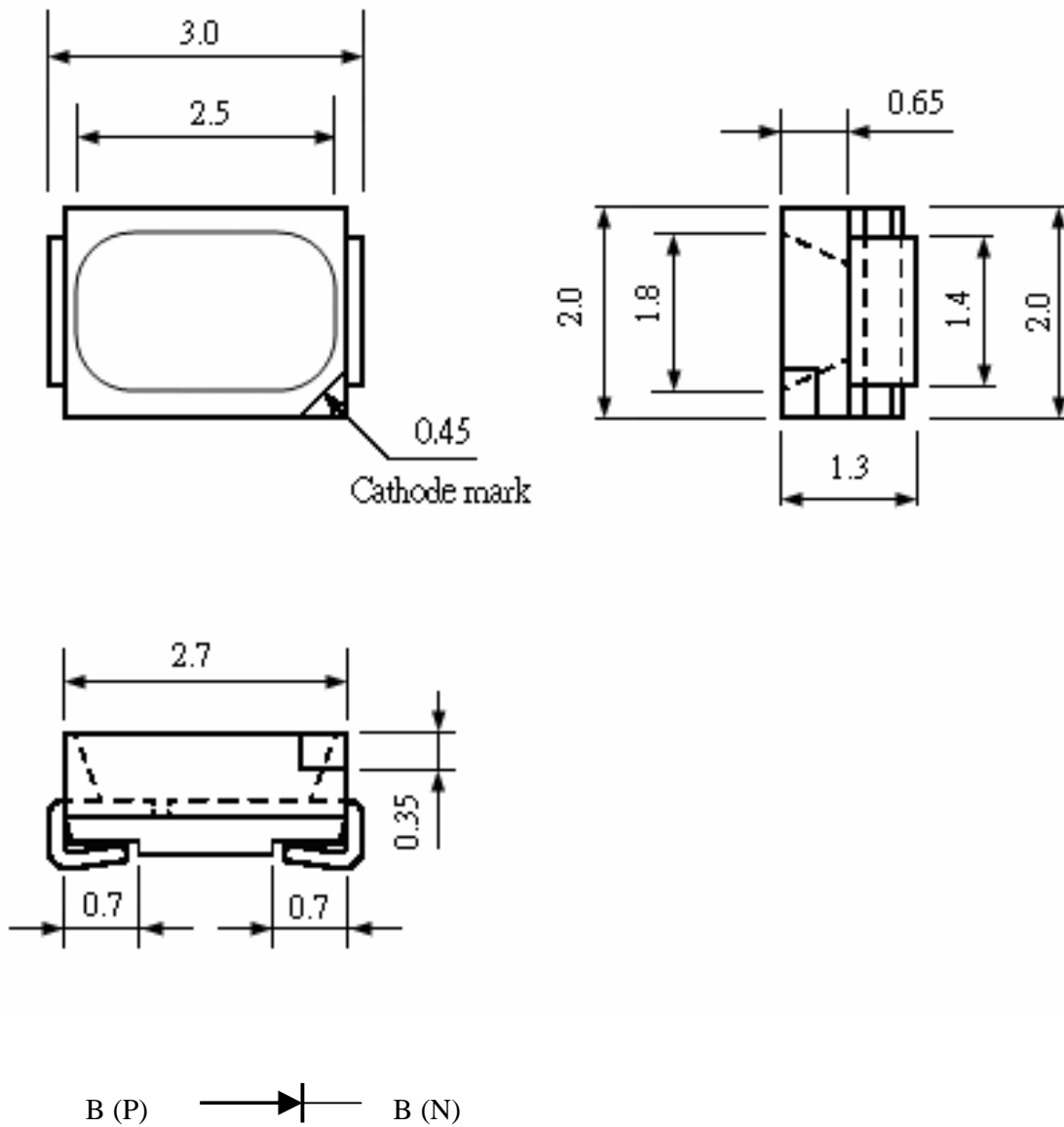

**Note:**

1. Unit: mm
2. Tolerance: Dimension  $\pm 0.15$  / Angle  $\pm 0.5^\circ$

## 4. ABSOLUTE MAXIMUM RATINGS ( $T_A=25^{\circ}\text{C}$ )

| Parameter                                   | Symbol               | Rating          | Unit                        |
|---|----------------------|-----------------|-----------------------------|
| Reverse Voltage                             | $V_R$                | 5               | V                           |
| Forward Current                             | $I_F$                | 30              | mA                          |
| Operating Temperature                       | $T_{opr}$            | -40 ~ +85       | $^{\circ}\text{C}$          |
| Storage Temperature                         | $T_{stg}$            | -40 ~ +100      | $^{\circ}\text{C}$          |
| Soldering Temperature                       | $T_{sol}$            | 260 (for 5 sec) | $^{\circ}\text{C}$          |
| Power Dissipation                           | $P_D$                | 114             | mW                          |
| Peak Forward Current<br>(Duty 1/10 @ 1KHz)  | $I_{F(\text{peak})}$ | 70              | mA                          |
| Junction temperature                        | $T_j$                | 110             | $^{\circ}\text{C}$          |
| Thermal Resistance<br>(Junction to ambient) | $R_{thJA}$           | 500             | $^{\circ}\text{C}/\text{W}$ |

## 5. ELECTRONIC OPTICAL CHARACTERISTICS

| Parameter                                     | Symbol          | Condition | PTA             | Unit |               |
|---|-----------------|-----------|-----------------|------|---------------|
| Chromaticity coordinate x<br>acc. To CIE 1931 | x               | IF=20mA   | 0.31            | ---  |               |
| Chromaticity coordinate y<br>acc. To CIE 1931 | y               | IF=20mA   | 0.31            | ---  |               |
| Viewing Angle                                 | $2\theta_{1/2}$ | IF=20mA   | 120             | Deg  |               |
| Forward Voltage                               | Max             | $V_F$     | IF=20mA         | 3.8  | V             |
|   | Typ             |           |                 | 3.4  |               |
| Reverse Current                               | Max             | $I_R$     | $V_R=5\text{V}$ | 50   | $\mu\text{A}$ |
|   | Typ             |           |                 |      |               |

## 6. LUMINOUS INTENSITY GROUPS:

| Luminous intensity group | Measurement condition | Luminous intensity Iv(mcd) |
|--------------------------|-----------------------|----------------------------|
| U                        | $I_F = 20 \text{ mA}$ | 1000 ~ 1650                |
| T2                       | $I_F = 20 \text{ mA}$ | 800 ~ 1000                 |
| T1                       | $I_F = 20 \text{ mA}$ | 700 ~ 800                  |
| S2                       | $I_F = 20 \text{ mA}$ | 600 ~ 700                  |

\* Luminous intensity group includes 4 groups S2 to U

\* Luminous intensity is tested at a current pulse duration of 25ms and a tolerance of  $\pm 10\%$

## 7. CHROMATICITY COORDINATES RANKS :

|    |       |       |    |       |       |    |       |       |
|----|-------|-------|----|-------|-------|----|-------|-------|
| a3 | 0.280 | 0.248 | b5 | 0.296 | 0.276 | b7 | 0.291 | 0.257 |
|    | 0.264 | 0.267 |    | 0.287 | 0.295 |    | 0.279 | 0.276 |
|    | 0.287 | 0.295 |    | 0.307 | 0.315 |    | 0.302 | 0.302 |
|    | 0.296 | 0.276 |    | 0.311 | 0.294 |    | 0.308 | 0.279 |
| b3 | 0.287 | 0.295 | b6 | 0.311 | 0.294 | b8 | 0.308 | 0.279 |
|    | 0.283 | 0.307 |    | 0.307 | 0.315 |    | 0.302 | 0.302 |
|    | 0.304 | 0.330 |    | 0.330 | 0.339 |    | 0.319 | 0.318 |
|    | 0.307 | 0.315 |    | 0.330 | 0.318 |    | 0.321 | 0.294 |
| b4 | 0.307 | 0.315 | d0 | 0.330 | 0.360 |    |       |       |
|    | 0.304 | 0.330 |    | 0.330 | 0.318 |    |       |       |
|    | 0.330 | 0.360 |    | 0.350 | 0.318 |    |       |       |
|    | 0.330 | 0.339 |    | 0.350 | 0.360 |    |       |       |

\* Color rank is tested at a current pulse duration of 25ms and a tolerance of the chromaticity coordinate of  $\pm 0.01$

## 8. FORWARD VOLTAGE :

| Bin | VF(Volt)  | Forward Current |
|-----|-----------|-----------------|
| VT1 | 3.00-3.40 | 20mA            |
| VT2 | 3.40-3.60 |                 |

\* Tolerance of Forward Voltage is  $\pm 0.05\text{V}$

## 9. TYPICAL ELECTRO-OPTICAL CHARACTERISTIC CURVES:

\* Chromaticity Coordinates (CIE 1931 system)

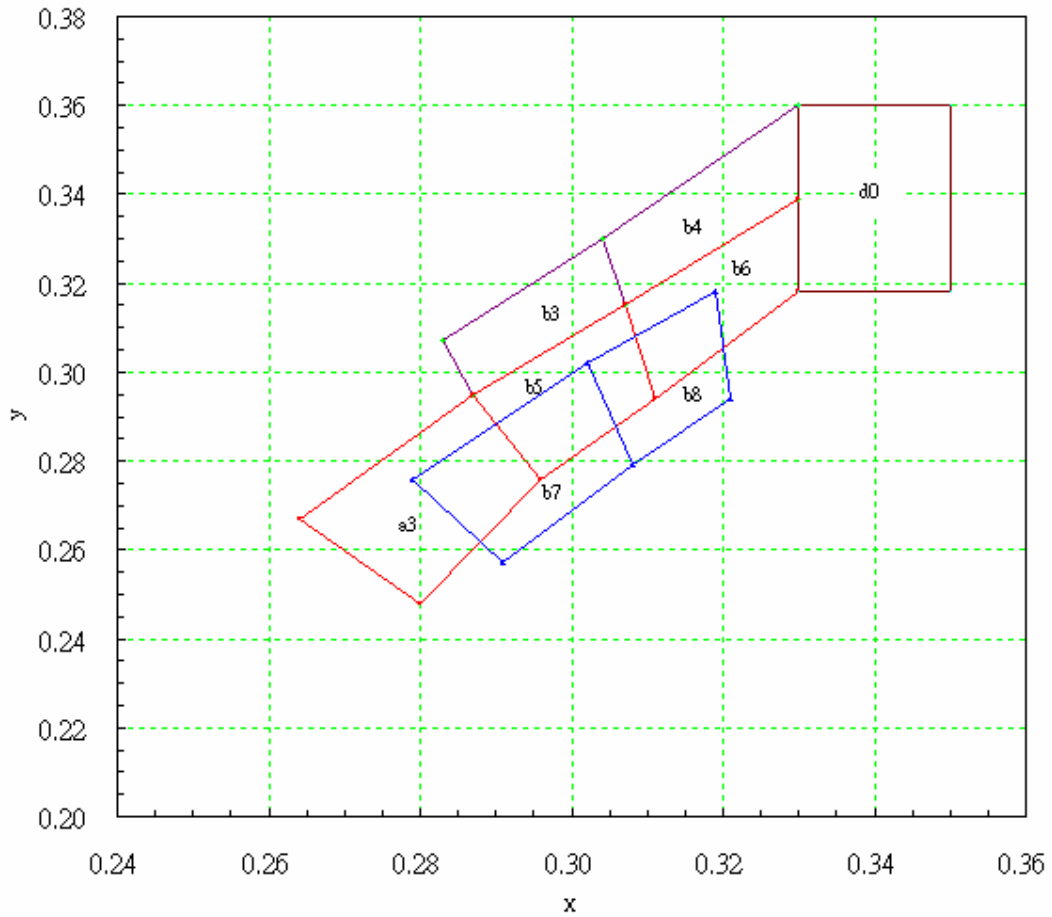

**\* Forward Voltage vs.  
Forward Current @25°C**

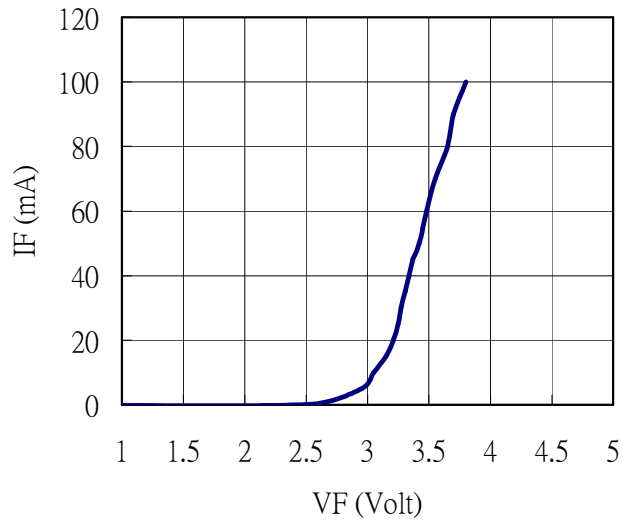

**Forward Current vs.  
Relative Luminosity @25°C**

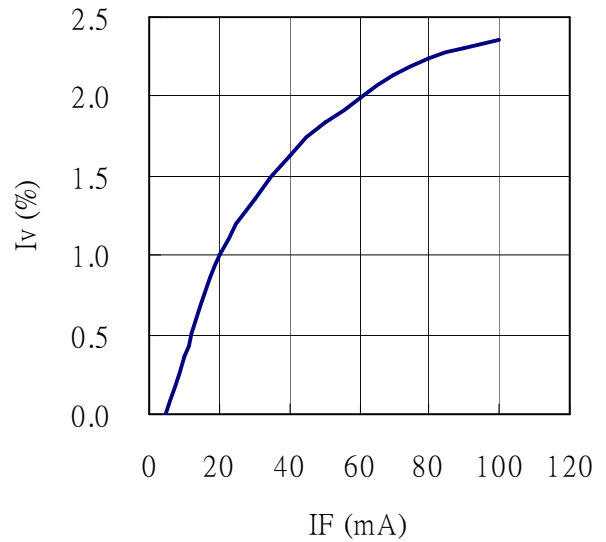

**\* Ambient Temperature vs.  
Forward Voltage @20mA**

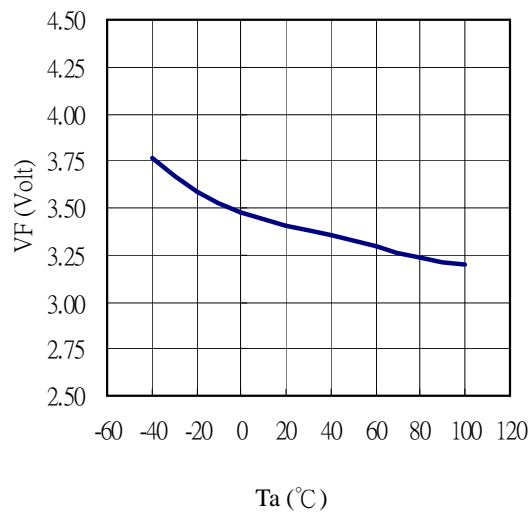

**\* Forward Current vs. Chromaticity diagram @ 25°C**

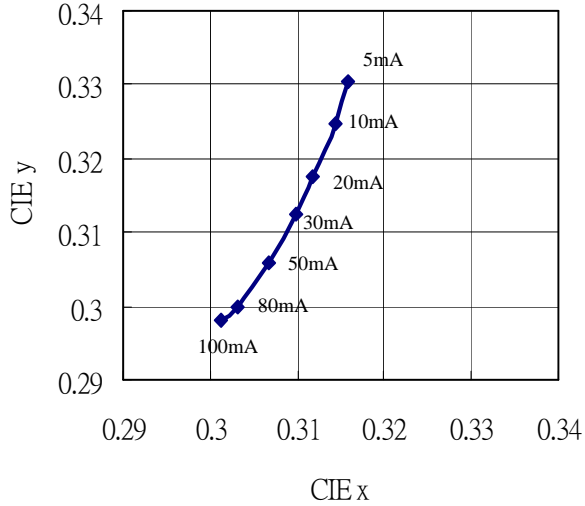

**\* Spectrum @ 20mA, 25°C**

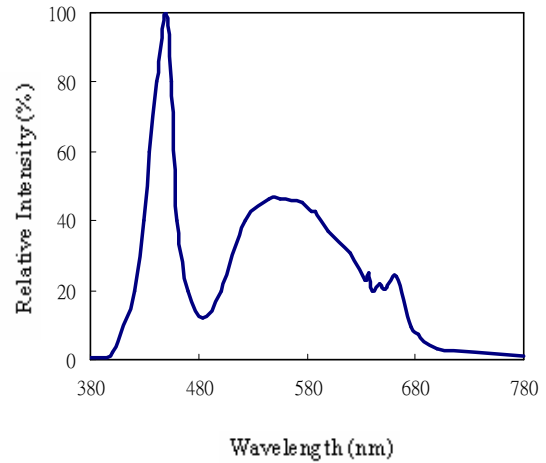

**\* Ambient Temperature vs. Chromaticity Diagram @ 20mA**

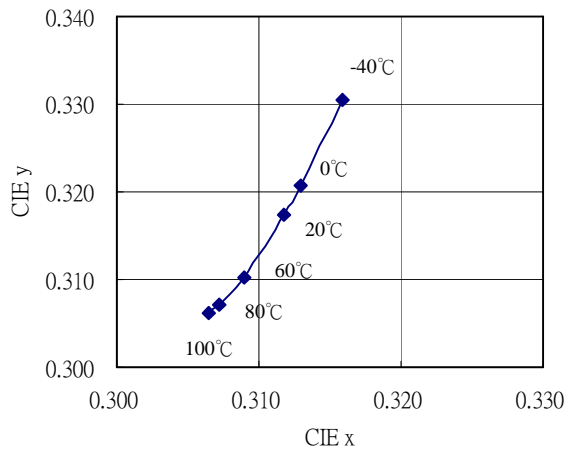

**\* Radiation Characteristic (@ 25°C, 20mA)**

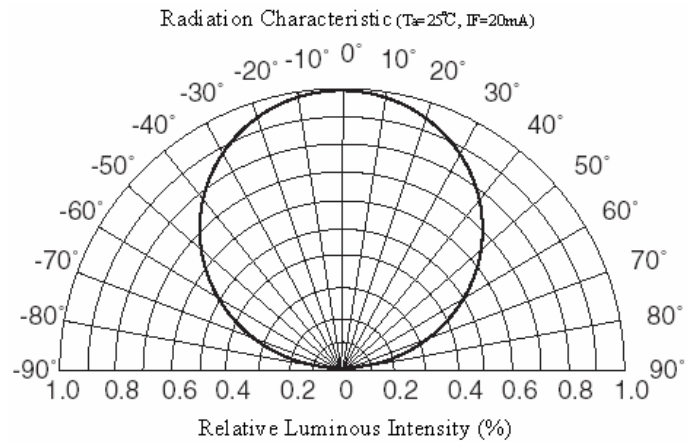



## 10. REEL PACKAGE:

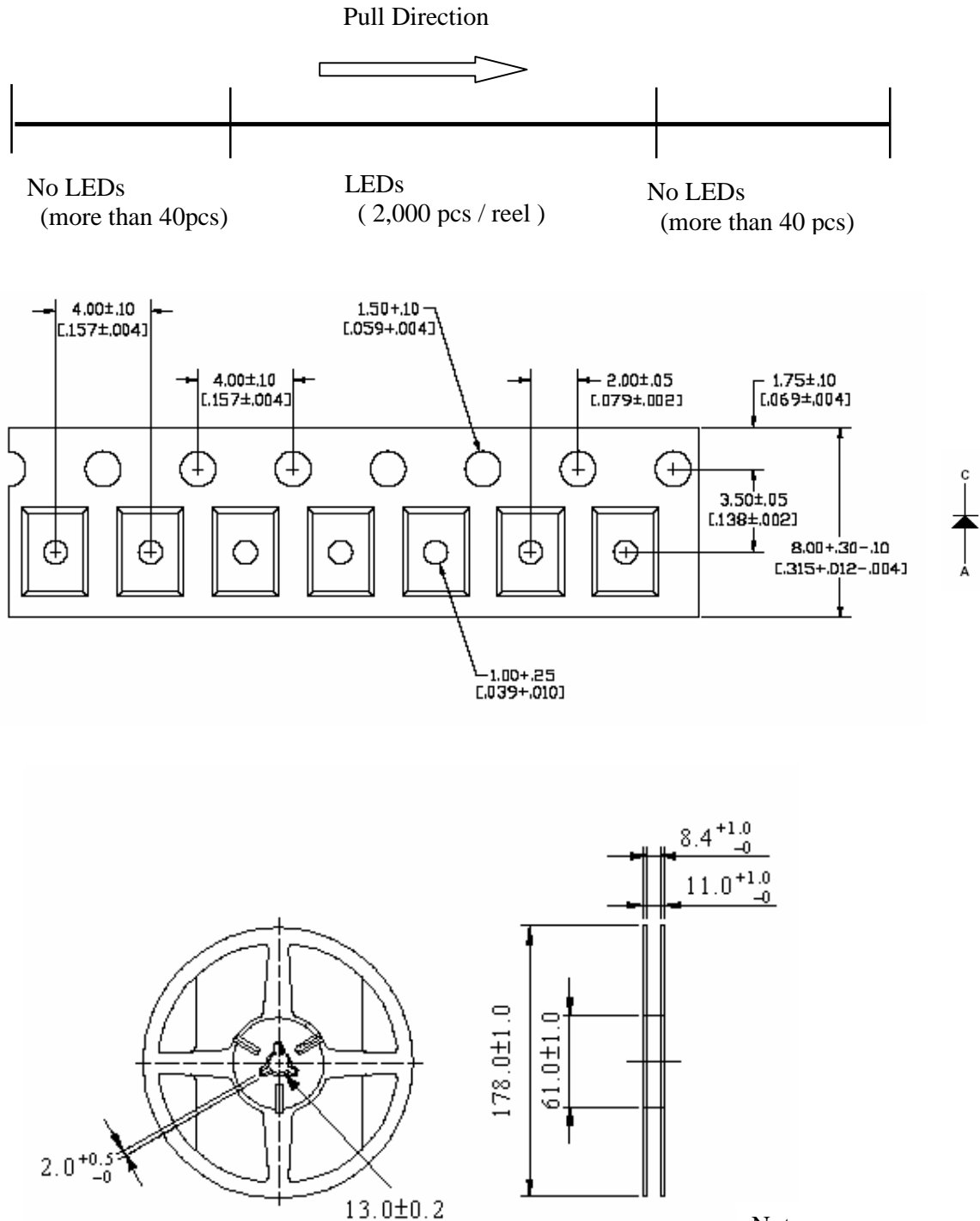

Note:  
 1. Unit: mm  
 2. 2,000 pcs / reel

### 11. RELIABILITY PLAN:

\* The reliability of products shall be satisfied with items listed below.

Confidence Level : 90 % , LTPD : 10 %

| No | Test Item                  | Description & Condition                                      |            | Sample size | Ac/Re | Failure Criteria  |
|----|----------------------------|--|------------|-------------|-------|---|
| 1  | Solderability              | Tsld =245±5°C, 10sec,  | 1 time     | 22          | 0/1   | IV < L* 0.6<br>(I <sub>F</sub> : 20mA)<br><br>V <sub>F</sub> > U * 1.1<br>(I <sub>F</sub> : 20mA)<br><br>I <sub>R</sub> > U * 2.0<br>(V <sub>R</sub> :5V)<br><br>L: Lower Spec.<br>Level<br><br>U: Upper Spec.<br>Level |
| 2  | Room Temperature operating | Ta = 25 °C<br>I <sub>F</sub> =20mA                           | 1000 hrs   | 22          | 0/1   |   |
| 3  | Room Temperature operating | Ta = 25 °C<br>I <sub>F</sub> = 30mA                          | 500 hrs    | 22          | 0/1   |   |
| 4  | High Temperature operating | Ta = 85 °C<br>I <sub>F</sub> =15mA                           | 500 hrs    | 22          | 0/1   |   |
| 5  | Low Temperature Storage    | Ta = -40 °C  | 1000 hrs   | 22          | 0/1   |   |
| 6  | High Temperature Storage   | Ta = 100 °C  | 1000 hrs   | 22          | 0/1   |   |
| 7  | Temperature Cycle          | -40°C ~ 25°C ~ 100°C<br>~ 25 °C<br>30min 5min 30min<br>5 min | 100 cycles | 22          | 0/1   |   |
| 8  | High Humidity Heat         | Ta = 60°C<br>RH=90%<br>I <sub>F</sub> = 15mA                 | 500 hrs    | 22          | 0/1   |   |

## 12. SOLDERING CONDITIONS:

### Re-flow Profile

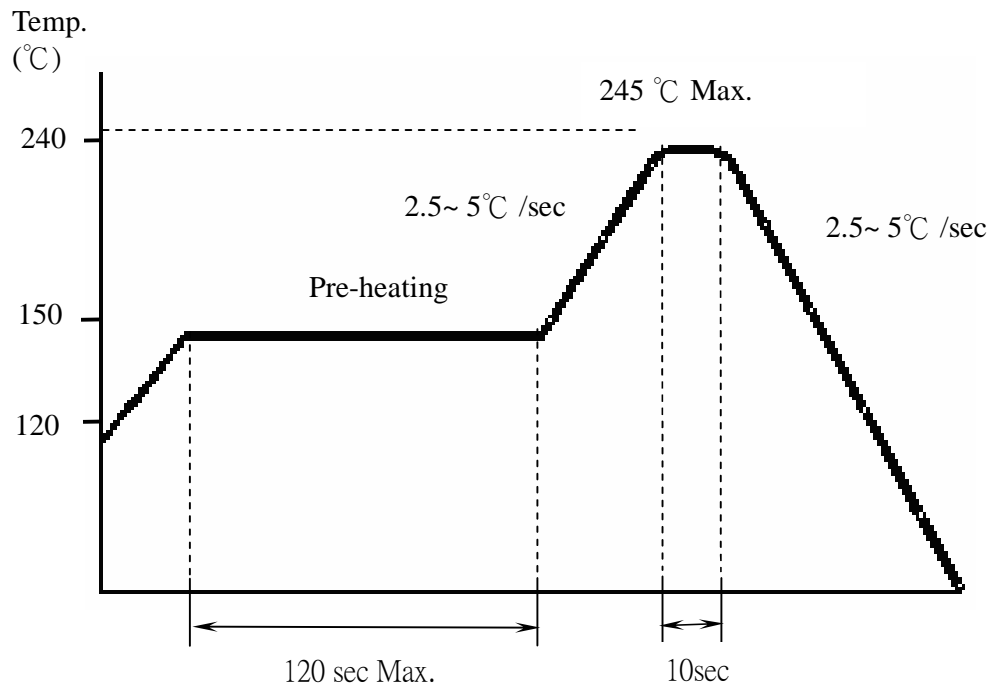

### Recommended Soldering Pad

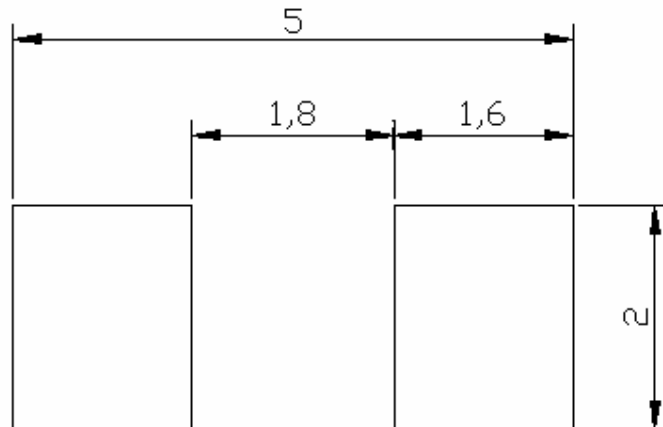

Note:  
1. Unit: mm

### 13. CAUTIONS:

#### (1)Storage

- Before opening the package :

The LEDs should be kept at 30°C or less and 30%RH~85%RH. The LEDs should be used within a year. When storing the LEDs, moisture proof packaging with desiccant (Silica gel)is recommended.

- After opening the package :

The LEDs should be kept at 30°C or less and 30%RH~70%RH.The LEDs should be soldered within 168hours (7days) after opening the package. If unused LEDs remain, they should be stored in moisture proof packages, such as sealed containers with packages of moisture desiccant (Silica gel), or reseal the moisture proof bag again.

If the moisture desiccant (Silica gel) has faded away or the LEDs have exceeded the storage time, baking treatment should be performed using the following conditions.

Baking treatment: more than 24 hours at 65°C.

Please avoid conditions which may cause the LED to corrode, tarnish or discolor. This corrosion or discoloration might lower solderability or might effect on optical characteristics. Please avoid rapid transitions in ambient temperature, especially in high humidity environments where condensation can occur.

- Moisture Proof package

When moisture is absorbed into the SMT package it may vaporize and expand during soldering. There is a possibility that this can cause exfoliation of the contacts and damage to the optical characteristics of the LEDs. For this reason, the moisture proof package is used to keep moisture to a minimum in the package. A package of a moisture desiccant (silica gel)is inserted into the moisture proof bag. The silica gel changes its color from blue to pink as it absorbs moisture.

#### (2)Static Electricity

- Static electricity or surge voltage damages the LEDs. It is recommended that a wrist band or an anti-electrostatic glove and shoe be used when handling the LEDs.
- All devices, equipment and machinery must be properly grounded. It is recommended that measures be taken against surge voltage to the equipment that mounts the LEDs.
- When inspecting the final products in which LEDs were assembled, it is recommended to check whether the assembled LEDs are damaged by static electricity or not. It is easy to End static-damaged LEDs by a light-on test or a  $V_F$  test at a lower current (below 1 mA).
- Damaged LEDs will show some unusual characteristics such as the leak current remarkably increases, the forward voltage becomes lower, or the LEDs do not light at the low current. (Criteria :  $V_F > 2.0V$  at  $I_F = 0.5mA$ .)

#### (3)Heat Generation

- Please consider the heat generation of the LED when making the system design that it's very importance. The coefficient of temperature increase per input electric power is affected by the thermal resistance of the circuit board and density of LED placement on the board, and other components. It is necessary to avoid intense heat generation and operate within the maximum ratings given in this specification.
- The operating current should be decided after considering the ambient maximum temperature of LEDs.

(4)Others

- Care must be taken to ensure that the reverse voltage will not exceed the absolute maximum rating when using the LEDs with matrix drive.
- The LED light output is strong enough to injure human eyes. Precautions must be taken to prevent looking directly for more than a few seconds. Flashing lights have been known to cause discomfort in people; you can prevent this by taking precautions during use. Also, people should be cautious when using equipment that has had LEDs incorporated into it.

AVA TECHNOLOGY CO. MAKES NO WARRANTY, REPRESENTATION OF GUARANTEE, EXPRESS OR IMPLIED, REGARDING THE SUITABILITY OF ITS PRODUCTS FOR ANY PARTICULAR PURPOSE, NOR THAT THE USE OR APPLICATION AND SPECIFICALLY DISCLAIMS ANY AND ALL LIABILITY ARISING OUT OF ANY SUCH USE OR APPLICATION, INCLUDING BUT NOT LIMITED TO, CONSEQUENTIAL OR INCIDENTAL DAMAGES.

AVA Technology CO. are not designed, intended or authorized for use as components in systems intended for surgical implant into the body, or other applications intended to support or sustain life, or for any other application in which the failure of the AVA Technology Co. Product could create a situation where personal injury or death may occur.

AVA Technology CO. reserves the right to make changes to or discontinue any product or service described herein without notice.